



WINSTAR Display Co.,Ltd.
華凌光電股份有限公司



Winstar Display Co., LTD

華凌光電股份有限公司



WEB: <https://www.winstar.com.tw> E-mail: sales@winstar.com.tw

SPECIFICATION

CUSTOMER : _____

MODULE NO.: WF0840ATWAMLNNO#

APPROVED BY: (FOR CUSTOMER USE ONLY)	PCB VERSION:	DATA:
--	---------------------	--------------

SALES BY	APPROVED BY	CHECKED BY	PREPARED BY
			葉虹蘭
ISSUED DATE: 2022/07/19			

TFT Display Inspection Specification: <https://www.winstar.com.tw/technology/download.html>

Precaution in use of TFT module: <https://www.winstar.com.tw/technology/download/declaration.html>



RECORDS OF REVISION

DOC. FIRST ISSUE

VERSION	DATE	REVISED PAGE NO.	SUMMARY
0	2022/01/19		First issue
A	2022/03/14		Correct Pixel pitch
B	2022/07/19		Modify Reliability

WINSTAR DISPLAY CO., Ltd.

Contents

1.Module Classification Information

2.Summary

3.General Specifications

4.Absolute Maximum Ratings

5.Electrical Characteristics

6.Timing characteristics

7.Optical Characteristics

8.Interface

9.Block Diagram

10.Reliability

11.Contour Drawing

12.Other

WINSTAR DISPLAY Co., Ltd.

1.Module Classification Information

W F 0840 A T W A M L N N 0 #
 ① ② ③ ④ ⑤ ⑥ ⑦ ⑧ ⑨ ⑩ ⑪ ⑫ ⑬

①	Brand : WINSTAR DISPLAY CORPORATION											
②	Display Type : F→TFT Type, J→Custom TFT											
③	Display Size : 084.0" TFT											
④	Model serials no.											
⑤	Backlight Type :	F→CCFL, White S→LED, High Light White					T→LED, White Z→Nichia LED, White					
⑥	LCD Polarize Type/ Temperature range/ Gray Scale Inversion Direction	A→Transmissive, N.T, IPS TFT C→Transmissive, N. T, 6:00 ; F→Transmissive, N.T,12:00 ; I→Transmissive, W. T, 6:00 K→Transflective, W.T,12:00 L→Transmissive, W.T,12:00 N→Transmissive, Super W.T, 6:00					Q→Transmissive, Super W.T, 12:00 R→Transmissive, Super W.T, O-TFT V→Transmissive, Super W.T, VA TFT W→Transmissive, Super W.T, IPS TFT X→Transmissive, W.T, VA TFT Y→Transmissive, W.T, IPS TFT Z→Transmissive, W.T, O-TFT					
⑦	A : TFT LCD B : TFT+SCREW HOLES+CONTROL BOARD C : TFT+ SCREW HOLES +A/D BOARD D : TFT+ SCREW HOLES +A/D BOARD+CONTROL BOARD E : TFT+ SCREW HOLES +POWER BOARD					F : TFT+CONTROL BOARD G : TFT+ SCREW HOLES H : TFT+D/V BOARD I : TFT+ SCREW HOLES +D/V BOARD J : TFT+POWER BD						
⑧	Resolution:											
	A	128160	B	320234	C	320240	D	480234	E	480272	F	640480
	G	800480	H	1024600	I	320480	J	240320	K	800600	L	240400
	M	1024768	N	128128	P	1280800	Q	480800	R	640320	S	480128
	T	800320	U	8001280	V	176220	W	1280398	X	1024250	Y	1920720
	Z	800200	2	1024324	3	7201280	4	19201200	5	1366768	6	1280320
⑨	D: Digital L : LVDS M:MIPI											
⑩	Interface:											
	N	Without control board			A	8Bit		B	16Bit		H	HDMI
	I	I2C Interface			R	RS232		S	SPI Interface		U	USB
⑪	TS:											
	N	Without TS			T	Resistive touch panel			C	Capacitive touch panel (G-F-F)		
	G	Capacitive touch panel (G-G)					C1	Capacitive touch panel (G-F-F)+OCA				
	C2	Capacitive touch panel (G-F-F)+OCR					G1	Capacitive touch panel (G-G)+OCA				
	G2	Capacitive touch panel (G-G)+OCR					B	CTP+GG+USB				
⑫	Version: X:Raspberry pi											
⑬	Special Code #:Fit in with ROHS directive regulations											

--	--	--

WINSTAR DISPLAY Co., Ltd.

2.Summary

TFT 8.4” is color TFT-LCD (Thin Film Transistor Liquid Crystal Display) ODF cell. The 8.4” screen produces a high-resolution image that is composed of 1024*BGR*768 pixel elements in a stripe arrangement.

WINSTAR DISPLAY Co., Ltd.

3. General Specifications

Item	Dimension	Unit
Screen Diagonal	8.4	inch
Number of Pixels	1024 x 3(BGR) x 768	dots
Module dimension	199.5 x 149.0 x 11.5	mm
Active area	170.8032 (H) x 128.1024(V)	mm
Pixel pitch	0.1668 x 0.1668	mm
Display Mode	Normally Black , Transmissive	
Viewing Angle	80/80/80/80	
TFT Drive IC	ST5821AH+ST5084AA or Equivalent	
TFT Interface	LVDS	
Backlight Type	LED, Normally White	
Aspect Ratio	4:3	
Side screw torque	Typ:0.9 Max:1.3 (Unit,Kgf-cm)	
With /Without TP	Without TP	
Surface	Anti-Glare	

*Color tone slight changed by temperature and driving voltage.

4. Absolute Maximum Ratings

Item	Symbol	Min	Typ	Max	Unit
Operating Temperature	TOP	-30	—	+80	°C
Storage Temperature	TST	-30	—	+80	°C

Note: Device is subject to be damaged permanently if stresses beyond those absolute maximum ratings listed above

1. Temp. $\leq 60^{\circ}\text{C}$, 90% RH MAX. Temp. $> 60^{\circ}\text{C}$, Absolute humidity shall be less than 90% RH at 60°C

WINSTAR DISPLAY Co., Ltd.

5. Electrical Characteristics

5.1. Operating conditions:

Item	Symbol	Min	Typ	Max	Unit	Remark
Supply Voltage For Logic	V _{DD}	3.0	3.3	3.6	V	—
Power Supply For Current	V _{DD} =3.3V	—	330	495	mA	—
Input Voltage	H level	V _{IH}	0.7V _{DD}	—	V _{DD}	SC.MODE
	L Level	V _{IL}	GND	—	0.3V _{DD}	

5.2. Backlight Characteristics

Parameter	Symbol	Min.	Typ.	Max.	Unit	Remark
Supply voltage of white LED backlight	V _{LED}	32.4	36	40.8	V	Note 1
Current for LED backlight	I _{LED}	—	70*2	—	mA	
LED life time	-	—	100,000	—	Hr	Note 3

Note 1 : There are 1 Groups LED

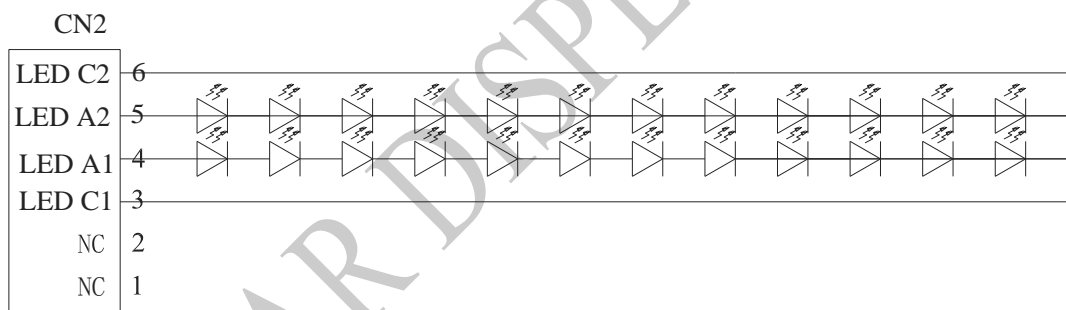

CIRCUIT DIAGRAM (12X 2=24 DICES)

Note 2 : T_a = 25 °C

Note 3 : Brightness to be decreased to 50% of the initial value

Note 4 : The single LED lamp case

6. Timing characteristics

6.1. LVDS Video timing

Parameter	Symbol	Value			Unit	Note
		Min.	Typ.	Max.		
CLK frequency	t _{CLK}	48.4	52.4	61.5	Mhz	
Horizontal blanking time	t _{HBT}	20	56	180	t _{CLK}	t _{HBP} + t _{HFP}
Horizontal back porch	t _{HBP}	5	5	180 - t _{HFP}	t _{CLK}	
Horizontal display area	t _{HD}	1024	1024	1024	t _{CLK}	
Horizontal front porch	t _{HFP}	15	51	175	t _{CLK}	
Horizontal period	t _H	1044	1080	1204	t _{CLK}	
Horizontal pulse width	t _{HPW}	1	1	256	t _{CLK}	
Vertical blanking time	t _{VBT}	5	40	83	t _H	t _{VBP} + t _{VFP}
Vertical back porch	t _{VBP}	2	2	83 - t _{VFP}	t _H	
Vertical display area	t _{VD}	768	768	768	t _H	
Vertical front porch	t _{VFP}	3	38	81	t _H	
Vertical period	t _V	773	808	851	t _H	
Vertical pulse width	t _{VPW}	1	1	128	t _H	

6.2. TCON mode LVDS interface data mapping

VESA data mapping

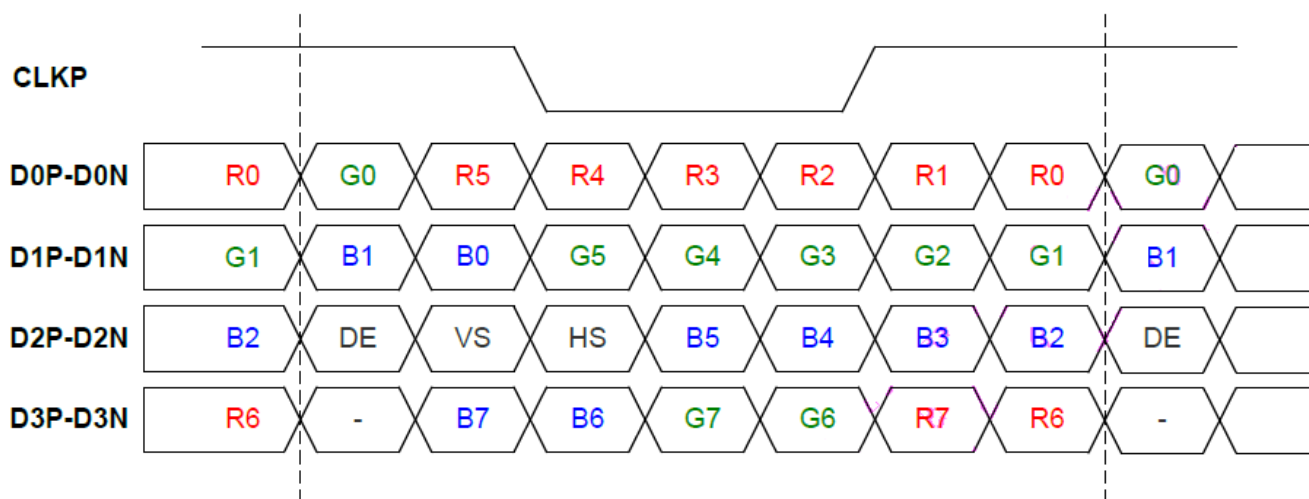

Note 1 : for 6 bit mode, MSB are R/G/B[5] and R/G/B[0] are LSB

Note 2 : for 8 bit mode, MSB are R/G/B[7] and R/G/B[0] are LSB

6.3. LVDS receiver characteristic

(Receiver Differential Input : D0P~D3P, D0N~D3N, CLKP, CLKN)

(VDD=VDD_LVDS=3.0~3.6V, GND=GND_LVDS=0V, TA=-40~95°C)

Parameter	Symbol	Min	Typ.	Max.	Unit	Conditions
Differential input high threshold voltage	R_{xVTH}			0.1	V	$R_{xVCM} = 1.2V$
Differential input low threshold voltage	R_{xVTL}	-0.1			V	
Input voltage range (singled-end)	R_{xVIN}	0		$VDD-1.0$	V	
Differential input common mode voltage	R_{xVCM}	0.6	1.2	$2.4 - V_{ID} / 2$	V	
Differential input voltage	$ V_{ID} $	0.2	0.4	0.6	V	
Differential input leakage current	R_{VxIz}	-10		10	μA	
LVDS Digital Operating Current	I_{VDD_LVDS}	-	25	35	mA	$F_{CLK}=65\text{ MHz}$, $VDD_LVDS=3.3V$ Data pattern=55/H → AA/H (loop)
LVDS Digital Stand-by Current	I_{STBD_LVDS}	-	10	50	μA	$RSTB=0$ or $STBYB=0$ All functions are stopped CLK & D0x connect to GND

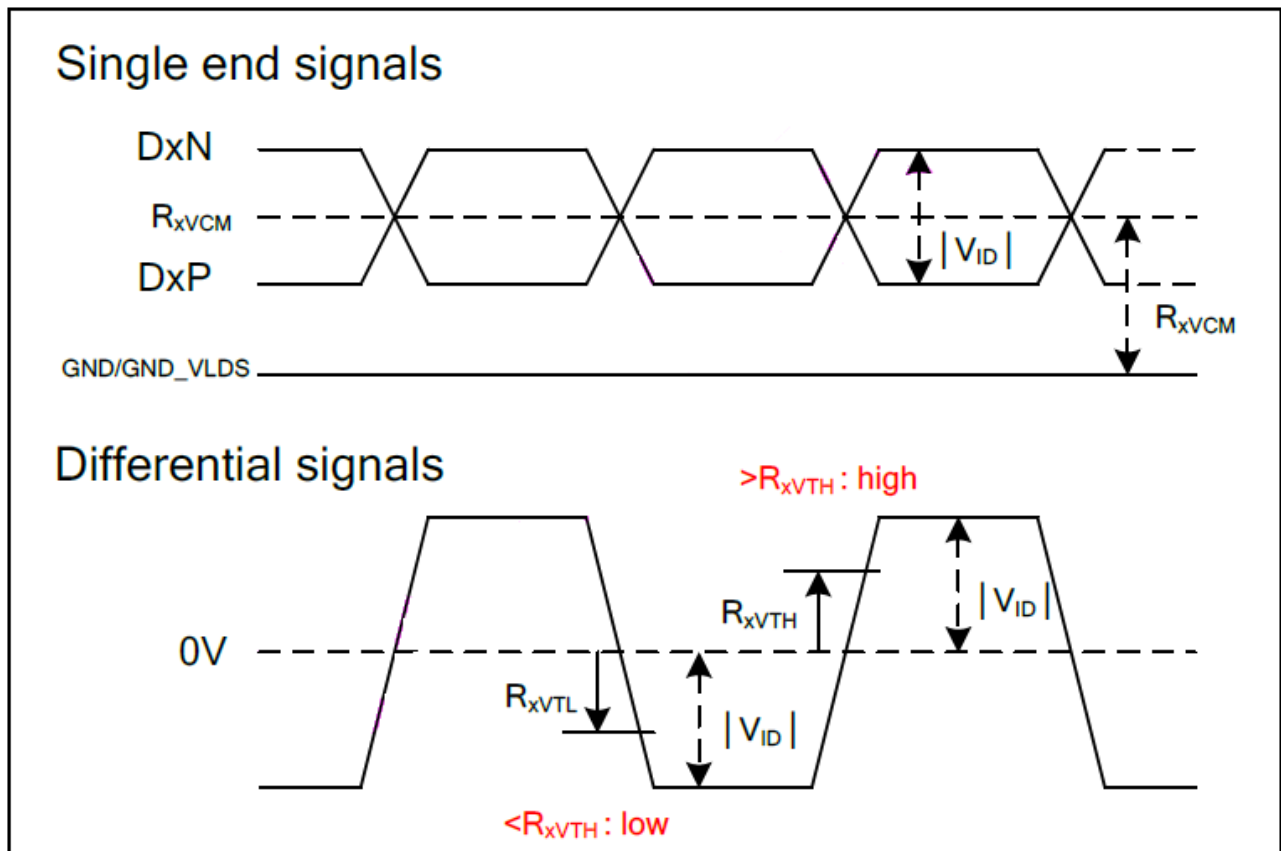

LVDS AC characteristic

(VDD=VDD_LVDS=3.0~3.6V, GND=GND_LVDS=0V, TA=-40~95°C)

Parameter	Symbol	Min	Typ.	Max.	Unit	Conditions
Clock Frequency	R_{XFCLK}	20		80	MHz	
Clock Period	R_{XTCLK}	12.5		50	ns	
1 data bit time	UI	-	1/7	-	R_{XTCLK}	
Clock high time	T_{LVCH}		4		UI	
Clock low time	T_{LVCL}		3		UI	
Position 1	T_{POS1}	-0.25	0	0.25	UI	
Position 2	T_{POS2}	0.75	-	1.25	UI	
Position 3	T_{POS3}	0.75	1	1.25	UI	
Position 4	T_{POS4}	1.75	-	2.25	UI	
Position 5	T_{POS5}	1.75	2	2.25	UI	
Position 6	T_{POS6}	2.75	-	3.25	UI	
Position 7	T_{POS7}	2.75	3	3.25	UI	
Position 8	T_{POS8}	3.75	-	4.25	UI	
Position 9	T_{POS9}	3.75	4	4.25	UI	
Position 10	T_{POS10}	4.75	-	5.25	UI	
Position 11	T_{POS11}	4.75	5	5.25	UI	
Position 12	T_{POS12}	5.75	-	6.25	UI	
Position 13	T_{POS13}	5.75	6	6.25	UI	
Position 14	T_{POS14}	6.75	-	7.25	UI	
Input eye width	T_{EYEW}	0.5	-	-	UI	
Input eye border	T_{EX}	-	-	0.25	UI	
PLL wake-up time	T_{enPLL}			150	us	

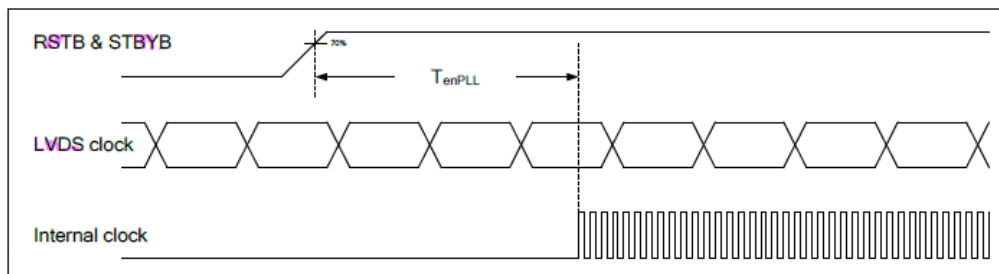
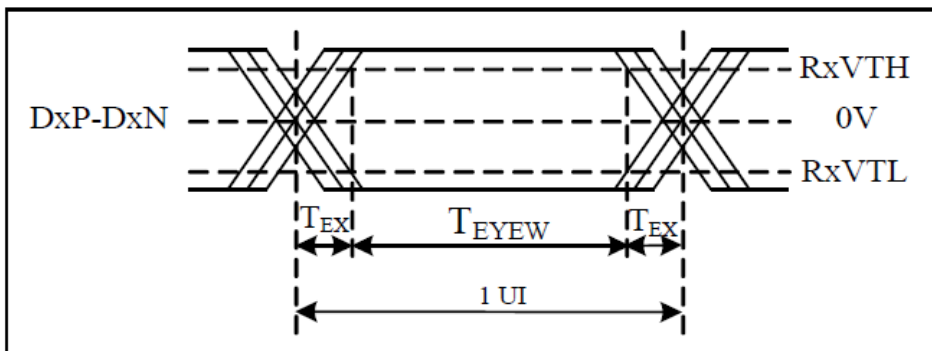
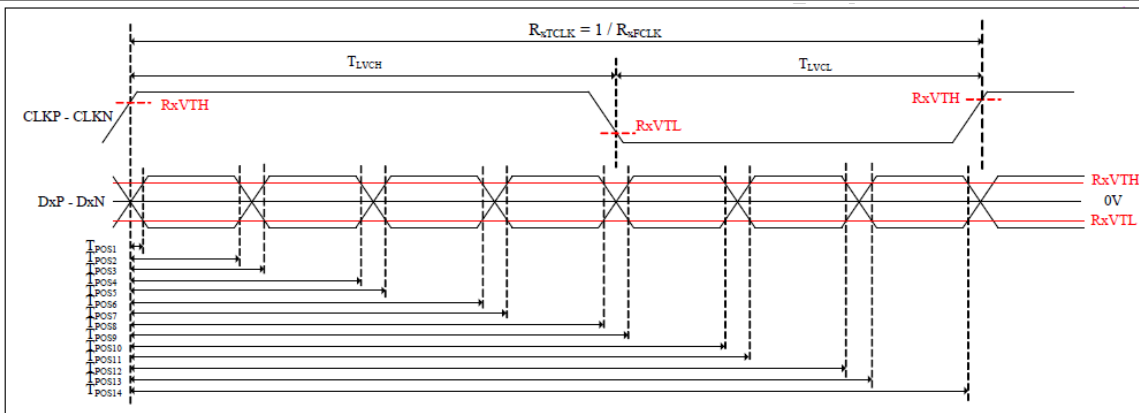

6.4. Power Sequence

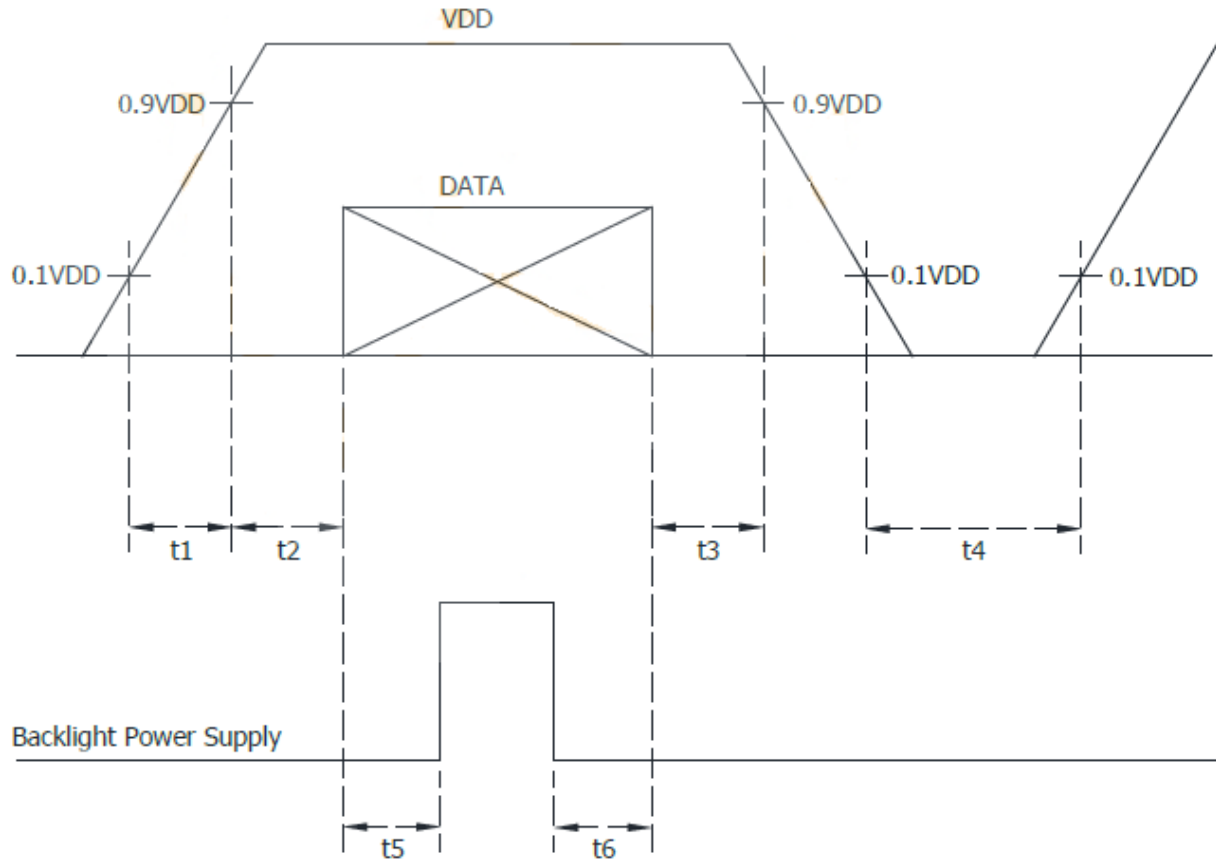

$1.5\text{ms} < t1 < 3\text{ms}$; $t2 > 100\text{ms}$

$t3 > 100\text{ms}$; $t4 > 200\text{ms}$

$t5 > 500\text{ms}$; $t6 > 500\text{ms}$

DATA : LVDS, MODE ,SC

WINSTAR DIS

7. Optical Characteristics

Item	Symbol	Condition.	Min	Typ.	Max.	Unit	Remark
Response time	Tr+ Tf	$\theta=0^\circ$ 、 $\phi=0^\circ$	-	25	35	.ms	Note 3
Contrast ratio	CR	At optimized viewing angle	800	1000	-	-	Note 4
Color Chromaticity	White	Wx	0.244	0.294	0.344	-	Note 2,6,7
		Wy	0.257	0.307	0.357	-	
Viewing angle	Hor.	Θ_R	-	80	-	Deg.	Note 1
		Θ_L	-	80	-		
	Ver.	Φ_T	-	80	-		
		Φ_B	-	80	-		
Brightness	-	-	400	500	-	cd/m ²	Center of display
Uniformity	(U)	-	70	-	-	%	Note 5

Ta=25±2°C

Note 1: Definition of viewing angle range

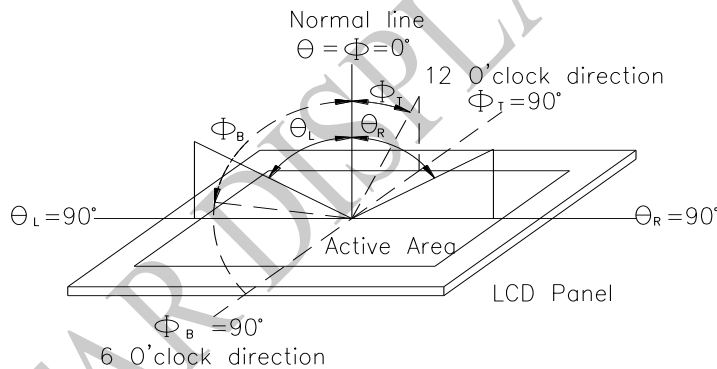

Fig. 7.1. Definition of viewing angle

Note 2: Test equipment setup:

After stabilizing and leaving the panel alone at a driven temperature for 10 minutes, the measurement should be executed. Measurement should be executed in a stable, windless, and dark room. Optical specifications are measured by Topcon BM-7 or BM-5 luminance meter 1.0° field of view at a distance of 50cm and normal direction.

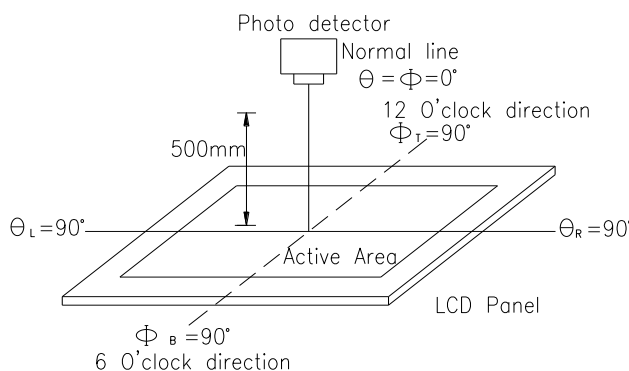
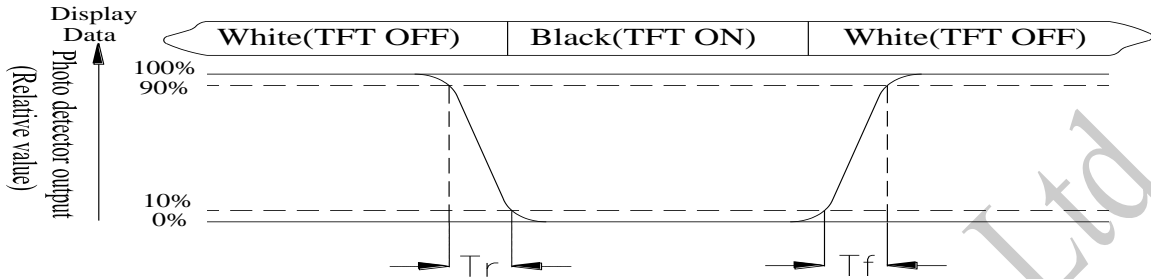

Fig. 7.2. Optical measurement system setup

Note 3: Definition of Response time:

The response time is defined as the LCD optical switching time interval between "White" state and "Black" state. Rise time, T_r , is the time between photo detector output intensity changed from 90% to 10%. And fall time, T_f , is the time between photo detector output intensity changed from 10% to 90%



Note 4: Definition of contrast ratio:

The contrast ratio is defined as the following expression.

$$\text{Contrast ratio (CR)} = \frac{\text{Luminance measured when LCD on the "White" state}}{\text{Luminance measured when LCD on the "Black" state}}$$

Note 5: Definition of Luminance Uniformity

Active area is divided into 9 measuring areas (reference the picture in below). Every measuring point is placed at the center of each measuring area.

$$\text{Luminance Uniformity (U)} = \text{Lmin/Lmax} \times 100\%$$

L = Active area length

W = Active area width

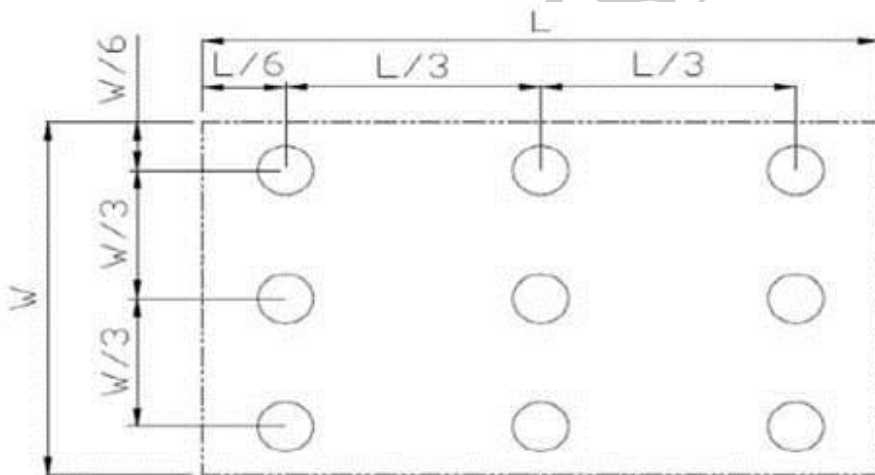

Fig7.3. Definition of uniformity

Note 6: Definition of color chromaticity (CIE 1931)

Color coordinates measured at the center point of LCD

Note 7: Measured at the center area of the panel when all the input terminals of LCD panel are electrically opened.

8.Interface

LCM PIN Definition

Pin No.	Symbol	Function	Remark
1	VDD	Power supply	
2	VDD	Power supply	
3	GND	Ground	
4	GND	Ground	
5	Link0-	0- LVDS differential data input (D0N)	
6	Link0+	0+ LVDS differential data input (D0P)	
7	GND	Ground	
8	Link1-	1- LVDS differential data input (D1N)	
9	Link1+	1+ LVDS differential data input (D1P)	
10	GND	Ground	
11	Link2-	2- LVDS differential data input (D2N)	
12	Link2+	2+ LVDS differential data input (D2P)	
13	GND	Ground	
14	CLKIN-	- LVDS differential clock input (CLKN)	
15	CLKIN+	+ LVDS differential clock input (CLKP)	
16	GND	Ground	
17	Link3-	3- LVDS differential data input (D3N)	
18	Link3+	3+ LVDS differential data input (D3P)	
19	MODE	Bit 6/8:Low(6 Bit);High(8 Bit)	
20	SC	Scan direction selector (Low: Normal ;High: Reverse)	

*Scan direction selector(SC):

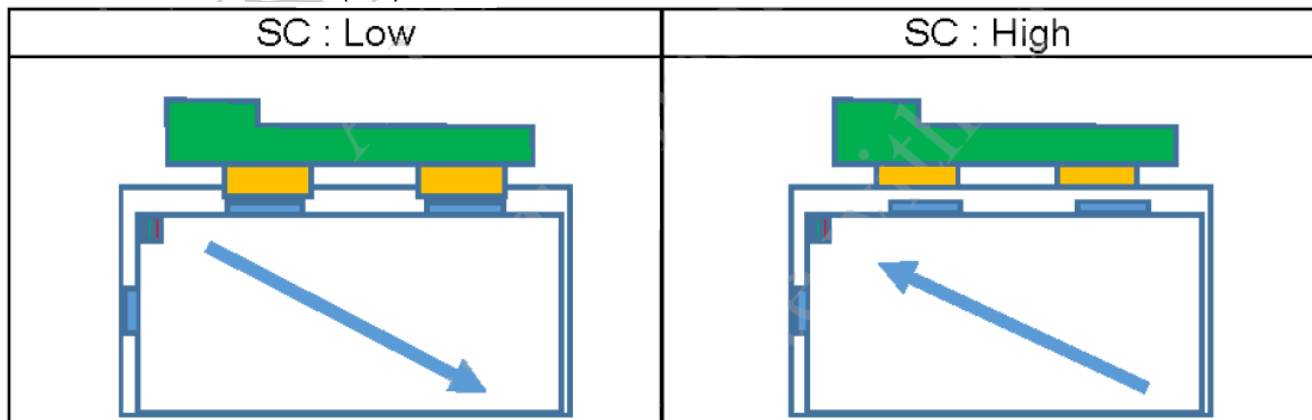

CN2

Pin No.	Symbol	Function	Remark
1	NC	No connection	
2	NC	No connection	
3	LED C1	LED_ Cathode 1	
4	LED A1	LED_ Anode 1	
5	LED A2	LED_ Anode 2	
6	LED C2	LED_ Cathode 2	

WINSTAR DISPLAY Co., Ltd.

9. Block Diagram

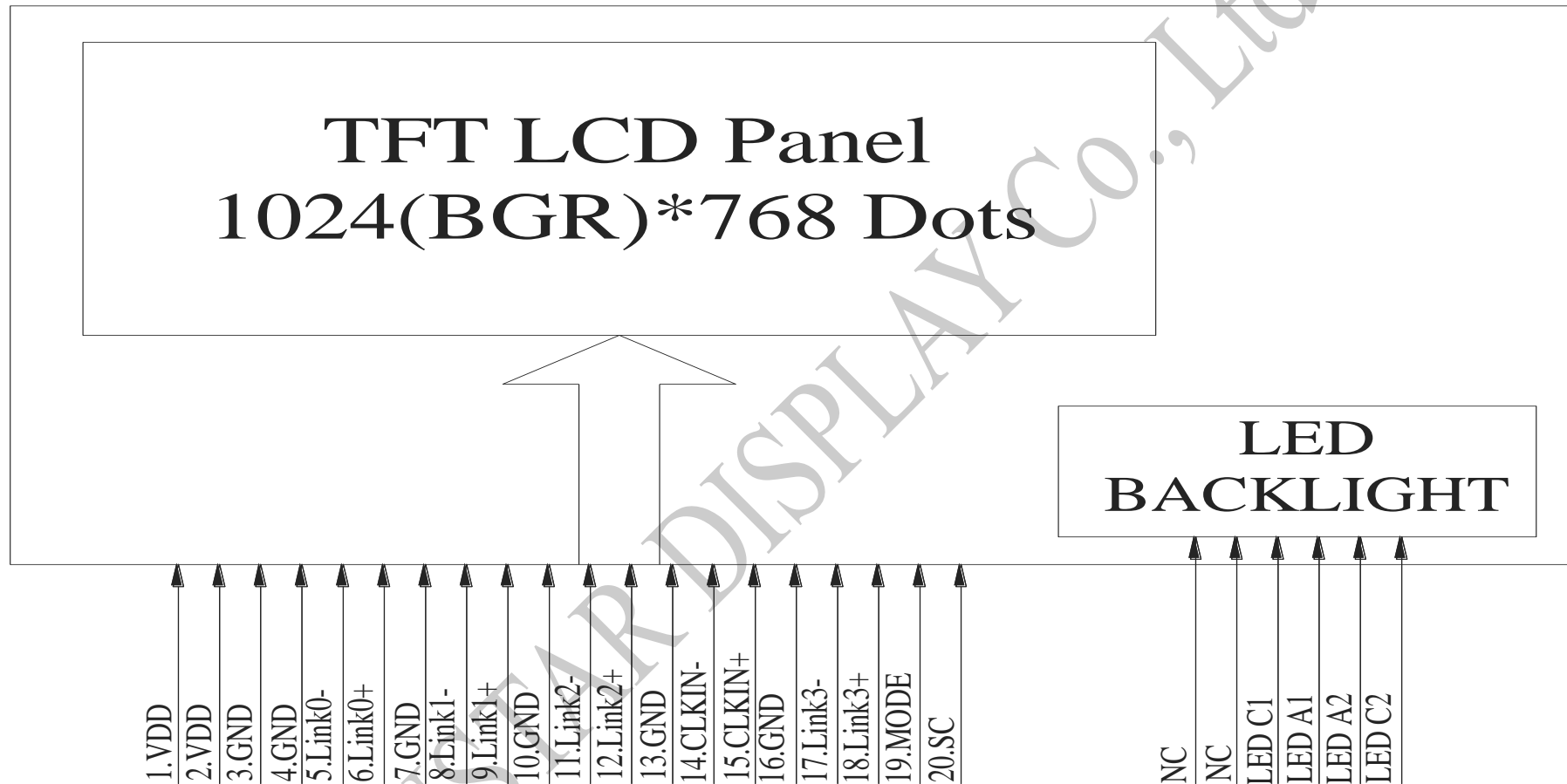

10. Reliability

Content of Reliability Test (Super Wide temperature, -30°C~80°C)

Environmental Test			
Test Item	Content of Test	Test Condition	Note
High Temperature storage	Endurance test applying the high storage temperature for a long time.	80°C 240hrs	2
Low Temperature storage	Endurance test applying the low storage temperature for a long time.	-30°C 240hrs	1,2
High Temperature Operation	Endurance test applying the electric stress (Voltage & Current) and the thermal stress to the element for a long time.	80°C 240hrs	—
Low Temperature Operation	Endurance test applying the electric stress under low temperature for a long time.	-30°C 240hrs	1
High Temperature/Humidity storage	The module should be allowed to stand at 40°C,90%RH max	40°C,90%RH 240hrs	1,2
Thermal shock resistance	The sample should be allowed stand the following 10 cycles of operation <div style="text-align: center;"> <p style="text-align: center;">-30°C 25°C 80°C</p> <p style="text-align: center;">1h ~ 1h</p> <p style="text-align: center;">1 cycle</p> </div>	-30°C/80°C 100 cycles	—
Vibration test	Endurance test applying the vibration during transportation and using.	Total fixed amplitude : 1.5mm Vibration Frequency : 10~55Hz One cycle 60 seconds to 3 directions of X,Y,Z for Each 15 minutes	3
Static electricity test	Endurance test applying the electric stress to the finished product housing.	Contact ±6KV Air ±8KV 10 times	4

Note1: No dew condensation to be observed.

Note2: The function test shall be conducted after 4 hours storage at the normal Temperature and humidity after remove from the test chamber.

Note3: The packing have to including into the vibration testing.

Note4: Some performance degradation allowed. Need Power off self-recoverable.
No hardware failure.

11. Contour Drawing

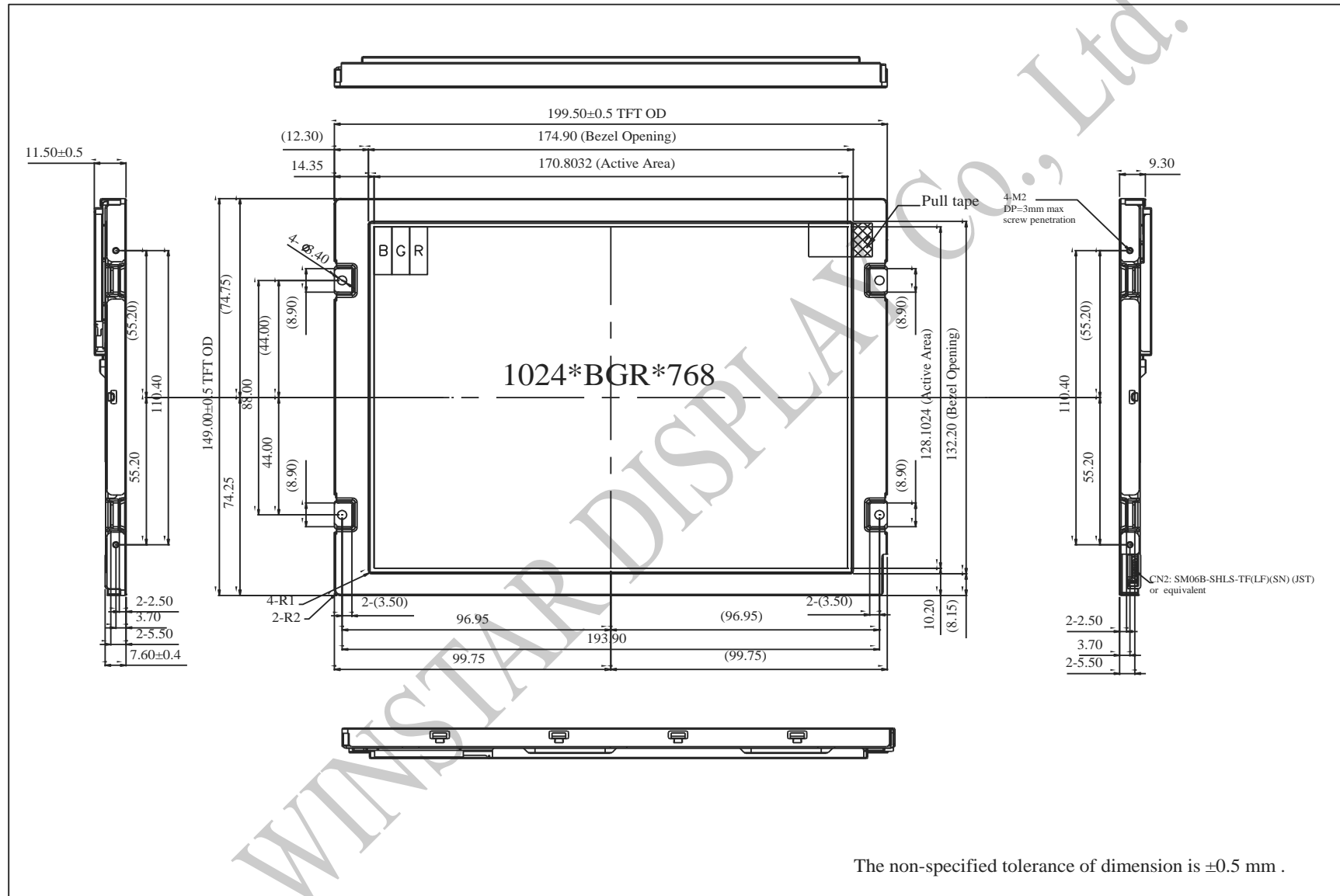

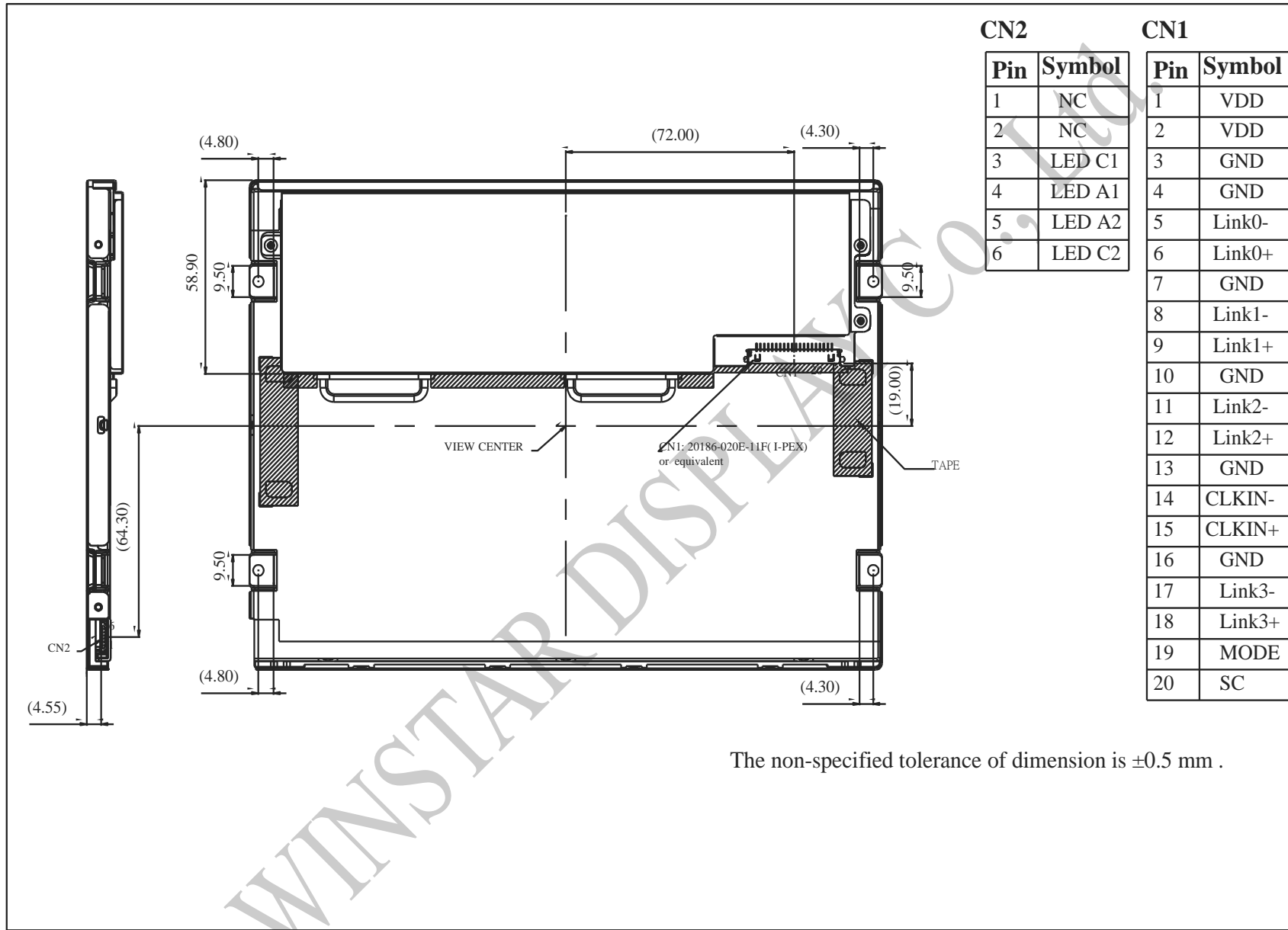



1、Panel Specification :

- 1. Panel Type : Pass NG , _____
- 2. View Direction : Pass NG , _____
- 3. Numbers of Dots : Pass NG , _____
- 4. View Area : Pass NG , _____
- 5. Active Area : Pass NG , _____
- 6. Operating : Pass NG , _____
- 7. Storage Temperature : Pass NG , _____
- 8. Others : _____

2、Mechanical

- 1. PCB Size : Pass NG , _____
- 2. Frame Size : Pass NG , _____
- 3. Material of Frame : Pass NG , _____
- 4. Connector Position : Pass NG , _____
- 5. Fix Hole Position : Pass NG , _____
- 6. Backlight Position : Pass NG , _____
- 7. Thickness of PCB : Pass NG , _____
- 8. Height of Frame to PCB : Pass NG , _____
- 9. Height of Module : Pass NG , _____
- 10. Others : Pass NG , _____

3、Relative Hole Size :

- 1. Pitch of Connector : Pass NG , _____
- 2. Hole size of Connector : Pass NG , _____
- 3. Mounting Hole size : Pass NG , _____
- 4. Mounting Hole Type : Pass NG , _____
- 5. Others : Pass NG , _____

4、Backlight Specification :

- 1. B/L Type : Pass NG , _____
- 2. B/L Color : Pass NG , _____
- 3. B/L Driving Voltage (Reference for LED) : Pass NG , _____
- 4. B/L Driving Current : Pass NG , _____
- 5. Brightness of B/L : Pass NG , _____
- 6. B/L Solder Method : Pass NG , _____
- 7. Others : Pass NG , _____



Winstar Module Number : _____

Page: 2

5、Electronic Characteristics of Module :

- 1. Input Voltage : Pass NG , _____
- 2. Supply Current : Pass NG , _____
- 3. Driving Voltage for LCD : Pass NG , _____
- 4. Contrast for LCD : Pass NG , _____
- 5. B/L Driving Method : Pass NG , _____
- 6. Negative Voltage Output : Pass NG , _____
- 7. Interface Function : Pass NG , _____
- 8. LCD Uniformity : Pass NG , _____
- 9. ESD test : Pass NG , _____
- 10. Others : Pass NG , _____

6、Summary :

Sales signature : _____

Customer Signature : _____

Date : / / _____

