



**WINSTAR Display Co.,Ltd.**  
**華凌光電股份有限公司**



# Winstar Display Co., LTD

## 華凌光電股份有限公司



WEB: <https://www.winstar.com.tw> E-mail: sales@winstar.com.tw

### SPECIFICATION

**CUSTOMER :** \_\_\_\_\_

**MODULE NO.:** WF104GSWFMLHBV#

<p><b>APPROVED BY:</b></p> <p>( FOR CUSTOMER USE ONLY )</p>	<p><b>PCB VERSION:</b> _____</p> <p><b>DATA:</b> _____</p>
---	--

SALES BY	APPROVED BY	CHECKED BY	PREPARED BY
			葉虹蘭
<b>ISSUED DATE: 2024/06/17</b>			

TFT Display Inspection Specification: <https://www.winstar.com.tw/technology/download.html>

Precaution in use of TFT module: <https://www.winstar.com.tw/technology/download/declaration.html>



**RECORDS OF REVISION**

**DOC. FIRST ISSUE**

VERSION	DATE	REVISED PAGE NO.	SUMMARY
0	2023/07/12		First issue
A	2024/06/17		Modify CTP.

# Contents

- 1.Module Classification Information
- 2.Summary
- 3.General Specifications
- 4.Absolute Maximum Ratings
- 5.Electrical Characteristics
- 6.Optical Characteristics
- 7.Interface
- 8.Reliability
- 9.Contour Drawing
- 10.Other

# 1.Module Classification Information

W F 104 G S W F M L H B V #  
 ① ② ③ ④ ⑤ ⑥ ⑦ ⑧ ⑨ ⑩ ⑪ ⑫ ⑬

①	Brand : WINSTAR DISPLAY CORPORATION											
②	Display Type : F→TFT Type, J→Custom TFT											
③	Display Size : 10.4" TFT											
④	Model serials no.											
⑤	Backlight Type :	F→CCFL, White S→LED, High Light White					T→LED, White Z→Nichia LED, White					
⑥	LCD Polarize Type/ Temperature range/ Gray Scale Inversion Direction	A→Transmissive, N.T, IPS TFT C→Transmissive, N. T, 6:00 ; F→Transmissive, N.T,12:00 ; I→Transmissive, W. T, 6:00 K→Transflective, W.T,12:00 L→Transmissive, W.T,12:00 N→Transmissive, Super W.T, 6:00					Q→Transmissive, Super W.T, 12:00 R→Transmissive, Super W.T, O-TFT V→Transmissive, Super W.T, VA TFT W→Transmissive, Super W.T, IPS TFT X→Transmissive, W.T, VA TFT Y→Transmissive, W.T, IPS TFT Z→Transmissive, W.T, O-TFT					
⑦	A : TFT LCD B : TFT+SCREW HOLES+CONTROL BOARD C : TFT+ SCREW HOLES +A/D BOARD D : TFT+ SCREW HOLES +A/D BOARD+CONTROL BOARD E : TFT+ SCREW HOLES +POWER BOARD					F : TFT+CONTROL BOARD G : TFT+ SCREW HOLES H : TFT+D/V BOARD I : TFT+ SCREW HOLES +D/V BOARD J : TFT+POWER BD						
⑧	Resolution:											
	A	128160	B	320234	C	320240	D	480234	E	480272	F	640480
	G	800480	H	1024600	I	320480	J	240320	K	800600	L	240400
	M	1024768	N	128128	P	1280800	Q	480800	R	640320	S	480128
	T	800320	U	8001280	V	176220	W	1280398	X	1024250	Y	1920720
	Z	800200	2	1024324	3	7201280	4	19201200	5	1366768	6	1280320
⑨	D: Digital L : LVDS M:MIPI											
⑩	Interface:											
	N	Without control board			A	8Bit		B	16Bit		H	HDMI
	I	I2C Interface			R	RS232		S	SPI Interface		U	USB
⑪	TS:											
	N	Without TS			T	Resistive touch panel			C	Capacitive touch panel (G-F-F)		
	G	Capacitive touch panel (G-G)					F	Capacitive touch panel (G-F)				
	C2	Capacitive touch panel (G-F-F)+OCR					G1	Capacitive touch panel (G-G)+OCA				
	G2	Capacitive touch panel (G-G)+OCR					B	CTP+GG+USB				
⑫	Version: X:Raspberry pi ; V: Raspberry pi 3B+											
⑬	Special Code	#:Fit in with ROHS directive regulations										

## **2.Summary**

TFT 10.4 " is a transmissive type color active matrix liquid crystal display (LCD), which uses amorphous thin film transistor (TFT) as switching devices. This panel has a 10.4 inches diagonally measured active display area with resolution 1024 x 768. This product is composed of a TFT LCD panel, polarizers, driver ICs, FPC and PCBA.

Note: Air-Bonding is recommended.

### 3. General Specifications

Item	Dimension	Unit
Size	10.4	inch
Dot Matrix	1024 x RGB x 768 (TFT)	dots
Module dimension	240.6 x 190.8 x 30.83	mm
Active area	210.432 x 157.824	mm
Pixel pitch	0.2055 X 0.2055	mm
LCD type	TFT, Normally Black, Transmissive	
Viewing Angle	80/80/80/80 min	
Aspect Ratio	4:3	
Controller IC	TFP401	
Backlight Type	LED ,Normally White	
Electrical Interface (Logic)	HDMI(only for DVI)	
CTP IC	ILI2511 or Equivalent	
CTP Interface	USB	
CTP FW Version	0x06.0x00.0x00.0x00.0x00.0x00.0x00.0x00	
CTP Resolution	16384*16384	
With /Without TP	With CTP	
Surface	Glare	
Assembly Instructions	Need to use edge measuring keyholes to perform fixing and support	

\*Color tone slight changed by temperature and driving voltage.

## 4. Absolute Maximum Ratings

Item	Symbol	Min	Typ	Max	Unit
Operating Temperature	TOP	-30	—	+80	°C
Storage Temperature	TST	-30	—	+80	°C

Note: Device is subject to be damaged permanently if stresses beyond those absolute maximum ratings listed above

1. Temp. 60°C, 90% RH MAX. Temp. > 60°C, Absolute humidity shall be less than 90% RH at 60°C



# 5. Electrical Characteristics

## 5.1. Operating conditions

Item	Symbol	Min	Typ	Max	Unit	Remark
Supply Voltage For LCM	12V	11.4	12.0	12.6	V	—
Supply Current For LCM	$I_{12V}$	—	940	1410	mA	Note 1
LED life time	—	-	100,000	-	Hr	Note 4

Note 1 : This value is test for VDD =5.0V , Ta=25°C only

Note 2 : Please make sure to support enough current

Note3 : Touch Panel driver is base on the mouse driver program and through USB port connect to PC or embedded board.Can only support the single touch.

Note 4: The “LED life time” is defined as the module brightness decrease to 50% original brightness at Ta=25°C and IL =490mA. The LED lifetime could be decreased if operating IL is lager than 490mA.

# 6. Optical Characteristics

Item	Symbol	Condition.	Min	Typ.	Max.	Unit	Remark	
Response time	Tr+ Tf	$\theta=0^\circ$ 、 $\Phi=0^\circ$	-	25	35	.ms	Note 3	
Contrast ratio	CR	At optimized viewing angle	800	1000	-	-	Note 4	
Color Chromaticity	White	Wx	$\theta=0^\circ$ 、 $\Phi=0$	0.269	0.319	0.369	-	Note 2,5,6
		Wy		0.319	0.369	0.419	-	
Viewing angle (Gray Scale Inversion Direction)	Hor.	$\Theta_R$	$CR \geq 10$	80	-	-	Deg.	Note 1
		$\Theta_L$		80	-	-		
	Ver.	$\Phi_T$		80	-	-		
		$\Phi_B$		80	-	-		
Brightness	-	-	700	800	-	cd/m <sup>2</sup>	Center of display	
Uniformity	(U)	-	70	-	-	%	Note 5	

Ta=25±2°C,

Note 1: Definition of viewing angle range

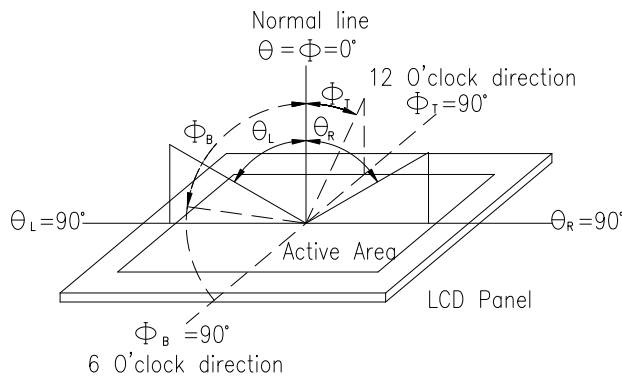

Fig. 6.1. Definition of viewing angle

Note 2: Test equipment setup:

After stabilizing and leaving the panel alone at a driven temperature for 10 minutes, the measurement should be executed. Measurement should be executed in a stable, windless, and dark room. Optical specifications are measured by Topcon BM-7 or BM-5 luminance meter 1.0° field of view at a distance of 50cm and normal direction.

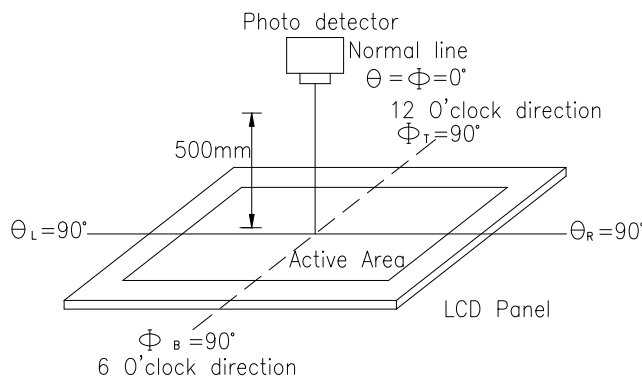
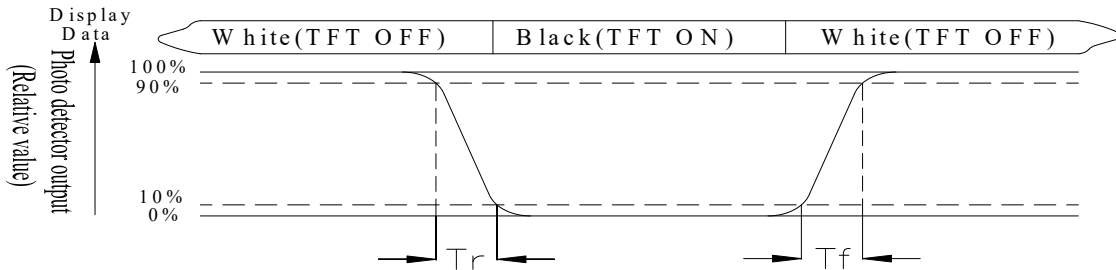

Fig. 6.2. Optical measurement system setup

Note 3: Definition of Response time:

The response time is defined as the LCD optical switching time interval between “White” state and “Black” state. Rise time,  $T_r$ , is the time between photo detector output intensity changed from 90% to 10%. And fall time,  $T_f$ , is the time between photo detector output intensity changed from 10% to 90%



Note 4: Definition of contrast ratio:

The contrast ratio is defined as the following expression.

$$\text{Contrast ratio (CR)} = \frac{\text{Luminance measured when LCD on the "White" state}}{\text{Luminance measured when LCD on the "Black" state}}$$

Note 5: Definition of Luminance Uniformity

Active area is divided into 9 measuring areas (reference the picture in below). Every measuring point is placed at the center of each measuring area.

Luminance Uniformity (U) =  $L_{\min}/L_{\max} \times 100\%$

L = Active area length

W = Active area width

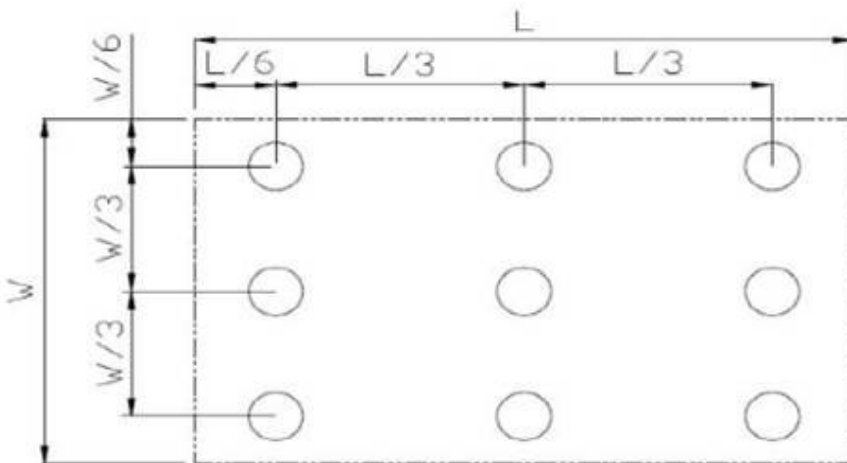

Fig6.3. Definition of uniformity

Note 6: Definition of color chromaticity (CIE 1931)

Color coordinates measured at the center point of LCD

Note 7: Measured at the center area of the panel when all the input terminals of LCD panel are electrically opened.

# 7.Interface

## 7.1. CN4

Pin No.	Symbol	Function	Remark
1	NC	No connection	Note1
2	5V	Raspberry Pi:Power 5V	
3	GPIO02	Raspberry Pi:GPIO02	
4	5V	Raspberry Pi:Power 5V	
5	GPIO03	Raspberry Pi:GPIO03	
6	GND	Raspberry Pi:GND	
7	GPIO04	Raspberry Pi:GPIO04	
8	GPIO14	Raspberry Pi:GPIO14	
9	GND	Raspberry Pi:GND	
10	GPIO15	Raspberry Pi:GPIO15	
11	GPIO17	Raspberry Pi:GPIO17	
12	GPIO18 (PWM_BL)	Backlight Enable,Active_H (Raspberry Pi:GPIO18)	Note 2.3.4
13	GPIO27	Raspberry Pi:GPIO27	
14	GND	Raspberry Pi:GND	
15	GPIO22	Raspberry Pi:GPIO22	
16	GPIO23	Raspberry Pi:GPIO23	
17	NC	No connection	Note1
18	GPIO24	Raspberry Pi:GPIO24	
19	GPIO10	Raspberry Pi:GPIO10	
20	GND	Raspberry Pi:GND	
21	GPIO09	Raspberry Pi:GPIO09	
22	GPIO25	Raspberry Pi:GPIO25	
23	GPIO11	Raspberry Pi:GPIO11	
24	GPIO08	Raspberry Pi:GPIO08	
25	GND	Raspberry Pi:GND	
26	GPIO07	Raspberry Pi:GPIO07	
27	ID_SD	Raspberry Pi:ID_SD	
28	ID_SC	Raspberry Pi:ID_SC	
29	GPIO05	Raspberry Pi:GPIO05	
30	GND	Raspberry Pi:GND	

31	GPIO06	Raspberry Pi:GPIO06	
32	GPIO12	Raspberry Pi:GPIO12	
33	GPIO13	Raspberry Pi:GPIO13	
34	GND	Raspberry Pi:GND	
35	GPIO19	Raspberry Pi:GPIO19	
36	GPIO16	Raspberry Pi:GPIO16	
37	GPIO26	Raspberry Pi:GPIO26	
38	GPIO20	Raspberry Pi:GPIO20	
39	GND	Raspberry Pi:GND	
40	GPIO21	Raspberry Pi:GPIO21	

Note1: The 3.3V supply current is limited; please pay special attention to use

## 7.2. CN5

Pin No.	Symbol	Function	Remark
1	3.3V	TFT Module Power limit can only output 3.3V,100mA	
2	5V	Raspberry Pi:Power 5V	
3	GPIO02	Raspberry Pi:GPIO02	
4	5V	Raspberry Pi:Power 5V	
5	GPIO03	Raspberry Pi:GPIO03	
6	GND	Raspberry Pi:GND	
7	GPIO04	Raspberry Pi:GPIO04	
8	GPIO14	Raspberry Pi:GPIO14	
9	GND	Raspberry Pi:GND	
10	GPIO15	Raspberry Pi:GPIO15	
11	GPIO17	Raspberry Pi:GPIO17	
12	GPIO18 (PWM_BL)	Backlight Enable ,Active_H (Raspberry Pi:GPIO18)	Note 2、3、4
13	GPIO27	Raspberry Pi:GPIO27	
14	GND	Raspberry Pi:GND	
15	GPIO22	Raspberry Pi:GPIO22	
16	GPIO23	Raspberry Pi:GPIO23	
17	3.3V	TFT Module Power limit can only output 3.3V,100mA	
18	GPIO24	Raspberry Pi:GPIO24	
19	GPIO10	Raspberry Pi:GPIO10	
20	GND	Raspberry Pi:GND	

21	GPIO09	Raspberry Pi:GPIO09	
22	GPIO25	Raspberry Pi:GPIO25	
23	GPIO11	Raspberry Pi:GPIO11	
24	GPIO08	Raspberry Pi:GPIO08	
25	GND	Raspberry Pi:GND	
26	GPIO07	Raspberry Pi:GPIO07	
27	ID_SD	Raspberry Pi:ID_SD	
28	ID_SC	Raspberry Pi:ID_SC	
29	GPIO05	Raspberry Pi:GPIO05	
30	GND	Raspberry Pi:GND	
31	GPIO06	Raspberry Pi:GPIO06	
32	GPIO12	Raspberry Pi:GPIO12	
33	GPIO13	Raspberry Pi:GPIO13	
34	GND	Raspberry Pi:GND	
35	GPIO19	Raspberry Pi:GPIO19	
36	GPIO16	Raspberry Pi:GPIO16	
37	GPIO26	Raspberry Pi:GPIO26	
38	GPIO20	Raspberry Pi:GPIO20	
39	GND	Raspberry Pi:GND	
40	GPIO21	Raspberry Pi:GPIO21	

Note 2 :Adjust the PWM signal in order to control LED Backlight's brightness. The higher the duty cycle, the lower the brightness.

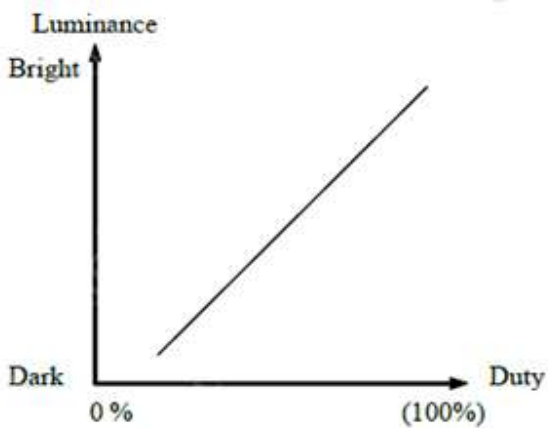

Note 3 : PWM signal operation frequency is 15KHz

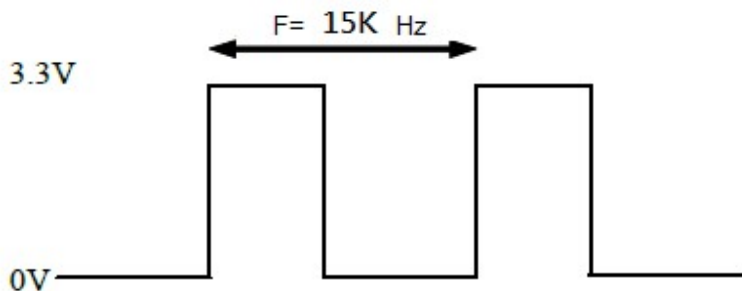

Note4 : Raspberry Pi Config Setting Examplpe : gpio=18=op,dh

### 7.3. DVI

Pin No.	Symbol	I/O	Function	Remark
1	Rx2+	I	Channel-2 positive receiver input; low-voltage signal differential- input pair.	
2	GND	P	Ground	
3	Rx2-	I	Channel-2 negative receiver input; low-voltage signal differential- input pair.	
4	Rx1+	I	Channel-1 positive receiver input; low-voltage signal differential- input pair.	
5	GND	P	Ground	
6	Rx1-	I	Channel-1 negative receiver input; low-voltage signal differential- input pair.	
7	Rx0+	I	Channel-0 positive receiver input; low-voltage signal differential- input pair.	
8	GND	P	Ground	
9	Rx0-	I	Channel-0 negative receiver input; low-voltage signal differential- input pair.	
10	RxC+	I	Clock positive receiver input; low-voltage signal differential- input pair.	
11	GND	P	Ground	
12	RxC-	I	Clock negative receiver input; low-voltage signal differential- input pair.	
13-14	NC	-	No connection	
15	SCL	I/O	DDC(Data Display Channel) Clock	
16	SDA	I/O	DDC(Data Display Channel) Data	
17	GND	P	Ground	
18	5V	P	Power Supply	
19	Detect	I/O	Hot plug detect	

I: input, O: output, P: Power

#### 7.4. CTP USB PIN Definition

Pin	Symbol	Function	Remark
1	5V	Power Supply (5V)	
2	D-	Data line -	
3	D+	Data line +	
4	NC	No connection	
5	GND	Power Ground	

#### 7.5. POWER JACK

Pin	Symbol	Function	Remark
1	12V	Power Supply (12.0V)	
2	GND	Power Ground	
3	NC	No connection	



# 8. Reliability

Content of Reliability Test (Super Wide temperature, -30°C~80°C)

Environmental Test			
Test Item	Content of Test	Test Condition	Note
High Temperature storage	Endurance test applying the high storage temperature for a long time.	80°C 200hrs	2
Low Temperature storage	Endurance test applying the low storage temperature for a long time.	-30°C 200hrs	1,2
High Temperature Operation	Endurance test applying the electric stress (Voltage & Current) and the thermal stress to the element for a long time.	80°C 200hrs	—
Low Temperature Operation	Endurance test applying the electric stress under low temperature for a long time.	-30°C 200hrs	1
High Temperature/ Humidity storage	The module should be allowed to stand at 60°C,90%RH max	60°C,90%RH 96hrs	1,2
Thermal shock resistance	The sample should be allowed stand the following 10 cycles of operation <div style="text-align: center;"> <p style="margin: 0;">-30°C    25°C    80°C</p> <p style="margin: 0;">30min    5min    30min</p> <p style="margin: 0;">1 cycle</p> </div>	-30°C/80°C 10 cycles	—
Vibration test	Endurance test applying the vibration during transportation and using.	Total fixed amplitude : 1.5mm Vibration Frequency : 10~55Hz One cycle 60 seconds to 3 directions of X,Y,Z for Each 15 minutes	3
Static electricity test	Endurance test applying the electric stress to the terminal.	VS=±8KV(contact), ±15KV(air), RS=330Ω CS=150pF 10 times	—

Note1: No dew condensation to be observed.

Note2: The function test shall be conducted after 4 hours storage at the normal Temperature and humidity after remove from the test chamber.

Note3: The packing have to including into the vibration testing.

# 9. Contour Drawing

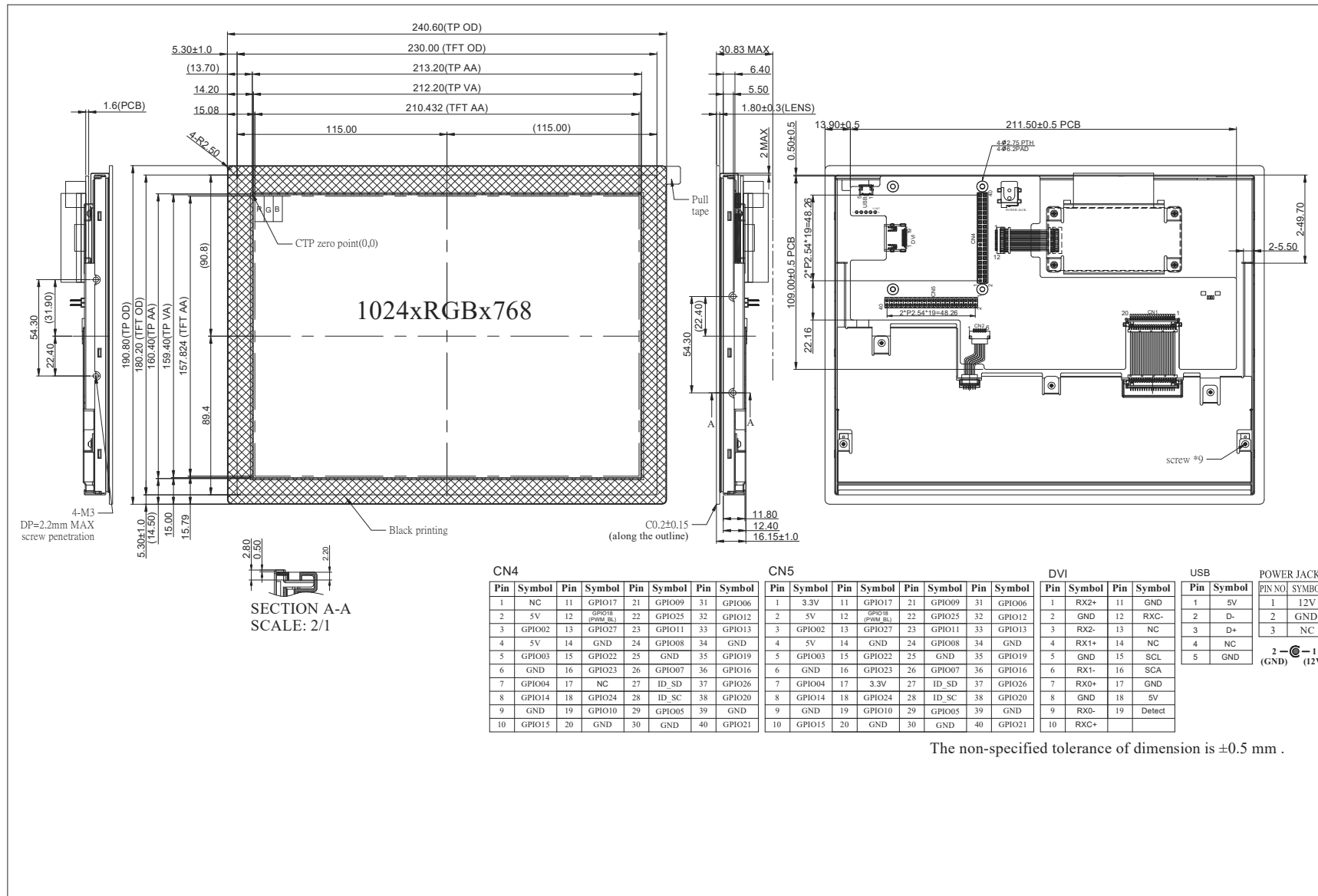



**1、Panel Specification :**

- 1. Panel Type :  Pass  NG , \_\_\_\_\_
- 2. View Direction :  Pass  NG , \_\_\_\_\_
- 3. Numbers of Dots :  Pass  NG , \_\_\_\_\_
- 4. View Area :  Pass  NG , \_\_\_\_\_
- 5. Active Area :  Pass  NG , \_\_\_\_\_
- 6. Operating Temperature :  Pass  NG , \_\_\_\_\_
- 7. Storage Temperature :  Pass  NG , \_\_\_\_\_
- 8. Others : \_\_\_\_\_

**2、Mechanical**

- 1. PCB Size :  Pass  NG , \_\_\_\_\_
- 2. Frame Size :  Pass  NG , \_\_\_\_\_
- 3. Material of Frame :  Pass  NG , \_\_\_\_\_
- 4. Connector Position :  Pass  NG , \_\_\_\_\_
- 5. Fix Hole Position :  Pass  NG , \_\_\_\_\_
- 6. Backlight Position :  Pass  NG , \_\_\_\_\_
- 7. Thickness of PCB :  Pass  NG , \_\_\_\_\_
- 8. Height of Frame to PCB :  Pass  NG , \_\_\_\_\_
- 9. Height of Module :  Pass  NG , \_\_\_\_\_
- 10. Others :  Pass  NG , \_\_\_\_\_

**3、Relative Hole Size :**

- 1. Pitch of Connector :  Pass  NG , \_\_\_\_\_
- 2. Hole size of Connector :  Pass  NG , \_\_\_\_\_
- 3. Mounting Hole size :  Pass  NG , \_\_\_\_\_
- 4. Mounting Hole Type :  Pass  NG , \_\_\_\_\_
- 5. Others :  Pass  NG , \_\_\_\_\_

**4、Backlight Specification :**

- 1. B/L Type :  Pass  NG , \_\_\_\_\_
- 2. B/L Color :  Pass  NG , \_\_\_\_\_
- 3. B/L Driving Voltage (Reference for LED Temperature) :  Pass  NG , \_\_\_\_\_
- 4. B/L Driving Current :  Pass  NG , \_\_\_\_\_
- 5. Brightness of B/L :  Pass  NG , \_\_\_\_\_
- 6. B/L Solder Method :  Pass  NG , \_\_\_\_\_
- 7. Others :  Pass  NG , \_\_\_\_\_

>> **Go to page 2** <<



Winstar      Module Number : \_\_\_\_\_

Page: 2

**5、Electronic Characteristics of Module :**

- |                              |                               |                               |       |
|------------------------------|-------------------------------|-------------------------------|-------|
| 1. Input Voltage :           | <input type="checkbox"/> Pass | <input type="checkbox"/> NG , | _____ |
| 2. Supply Current :          | <input type="checkbox"/> Pass | <input type="checkbox"/> NG , | _____ |
| 3. Driving Voltage for LCD : | <input type="checkbox"/> Pass | <input type="checkbox"/> NG , | _____ |
| 4. Contrast for LCD :        | <input type="checkbox"/> Pass | <input type="checkbox"/> NG , | _____ |
| 5. B/L Driving Method :      | <input type="checkbox"/> Pass | <input type="checkbox"/> NG , | _____ |
| 6. Negative Voltage Output : | <input type="checkbox"/> Pass | <input type="checkbox"/> NG , | _____ |
| 7. Interface Function :      | <input type="checkbox"/> Pass | <input type="checkbox"/> NG , | _____ |
| 8. LCD Uniformity :          | <input type="checkbox"/> Pass | <input type="checkbox"/> NG , | _____ |
| 9. ESD test :                | <input type="checkbox"/> Pass | <input type="checkbox"/> NG , | _____ |
| 10. Others :                 | <input type="checkbox"/> Pass | <input type="checkbox"/> NG , | _____ |

**6、Summary :**

Sales signature : \_\_\_\_\_

Customer Signature : \_\_\_\_\_

Date :      /      /      \_\_\_\_\_