



WINSTAR Display Co.,Ltd.
華凌光電股份有限公司



Winstar Display Co., LTD

華凌光電股份有限公司



WEB: <https://www.winstar.com.tw> E-mail: sales@winstar.com.tw

SPECIFICATION

CUSTOMER : Winstar

MODEL NO. : WLEP02566400DGAAASA00

<p>APPROVED BY: (FOR CUSTOMER USE ONLY)</p>	
--	--

SALES BY	APPROVED BY	CHECKED BY	PREPARED BY
	Ginger Xu William Lee	Jack Weng Purry Wu Aaron Xu Robert Weng Hui Huang	Kyra Chen

VERSION	DATE	REVISED PAGE NO.	SUMMARY
B	2022/04/15	13	Modify SW descriptions

RECORDS OF REVISION			DOC. FIRST ISSUE
VERSION	DATE	REVISED PAGE NO.	SUMMARY
A	2022/01/26		First issue
B	2022/04/15	13	Modify SW descriptions

WINSTAR DISPLAY Co., Ltd.

Contents

1. Smart Display Classification Information
2. Summary
3. Product information
4. Contour Drawing
5. Absolute Maximum Ratings
6. Electrical Characteristics
7. Block diagram
8. Interface
9. Reliability
10. Display Usage
11. Example Screen Layout
12. References

WINSTAR DISPLAY Co., Ltd.

1. Smart Display Classification Information

W	L	EP	025664	00D	G	A	AA	S	A	00
①	②	③	④	⑤	⑥	⑦	⑧	⑨	⑩	⑪

①	W: WINSTAR products									
②	Type: L:Standard K:Customization									
③	Display Type:	Standard:	OH: Character STN OX: Graphic STN (TAB/COF) OF: TFT EH: Character OLED EX: OLED (TAB/COF)	OG: Graphic STN OP: Graphic STN (COG) EG: Graphic OLED EP: OLED (COG)						
		Customization:	DH: Character DN: Graphic ED: OLED	DG: Graphic STN OJ: TFT						
④	Display size: (diagonal) / Display format: (resolution)	Character STN:	e.g., 8x1: 000801 16x2: 001602 24x4: 002404							
		Graphic STN:	e.g., 128x64: 012864 320x240: 320240							
		TFT Size (inch):	000096-0.96" / 000350-3.5" / 000430-4.3" / 000570-5.7" 000700-7.0" / 000800-8.0" / 001020-10.2" / 001210-12.1" (The last two digits are two digits after the decimal point)							
	OLED:	e.g., 128x64: 012864 Customization: 0001XX								
⑤	Serial No:	0A1 ~ 0ZZ	Customization STN: 000							

⑥	Touch Panel Type:	N: Without TP T: RTP G: CTP			
⑦	Model Interface:	A: CAN B: Bluetooth C: Controller Specified D: RS485 E: RS232 F: USART G: Logic I/O	H: HDMI R: Memory Specified P: RS422 N: Ethernet J: Analog I/O K: USB L: WIFI M: Zigbee	X: Combined Y: Proprietary interface	
⑧	Interface Serial No.:	AA ~ ZZ			
⑨	Control Category:	S: Smart Display N: Non-specified E: Entry			
⑩	Special Code:	A ~ Z			
⑪	Model code:	00 ~ ZZ			

2. Summary

SmartDisplay OLED 3.55” is an OLED type display with 256x64 resolution. Here are the summaries of the feature:

1. DC 5V working voltage.
2. Power-On Self-Test & Splash screen.
3. CAN bus Interface.
4. Supports CANopen protocol, default baud rate at 250KB.
5. Built in flash memory, store the font and Object Dictionary Data.
6. Supports PCAP touch screen.
7. Can Smart Display is defined as a slave device, which is controlled by master device via CAN bus command to render display content on the display screen and return touch event data with protocol objects.
8. Built-in Buzzer is controlled from master device.

WINSTAR DISPLAY Co., Ltd.

3. Product information

3.1 Mechanical Data

Item	Standard Value	Unit
OLED panel	100.4(W) x 36.1(H) x 3.39(D)	mm
PCB	157.0(W) x 40.0(H) x 1.6(D)	mm
Housing outline	157.0(W) x 40.0(H) x 11.45(D)	mm

3.2 General information

Item	Standard Value	Unit
Operating voltage	5	Vdc
Communication Interface	CAN bus differential ± 3.3	Vpp
MCU	STM32F750	NA
Flash Memory	16	MB
SDRAM Frequency	108	MHz
Size	3.55	inch
Dot Matrix	256 x 64	pixel
Module dimension	107(W)*68.7(H)*27(D)	mm
Active area	95.04 x 53.856	mm
Dot pitch	0.342 x 0.333	mm
LCD type	OLED, White color, Passive Matrix	
Drive Duty	1/64 Duty	
Gray Scale	4 bits	
With /Without TP	With CTP	
Surface	Glare	

4. Contour Drawing

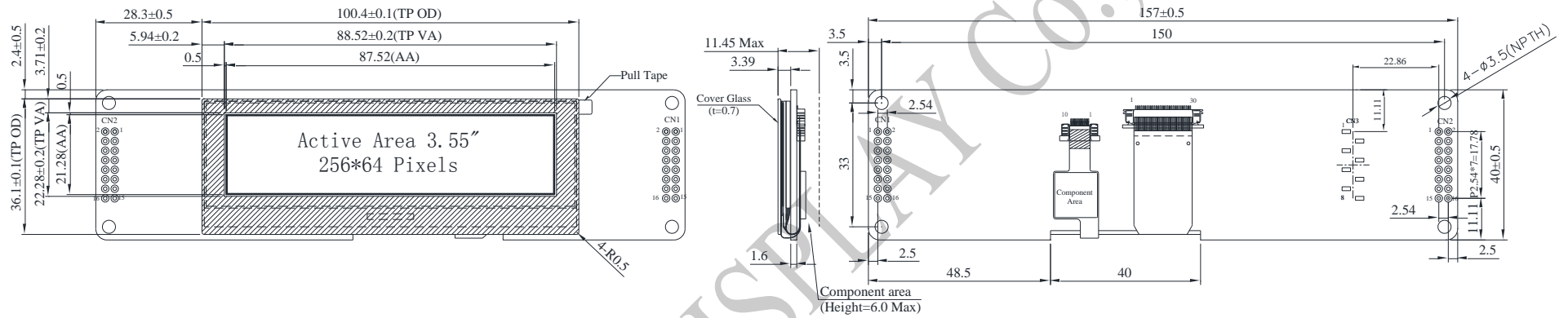

CN1		CN2	
PIN	SYMBOL	PIN	SYMBOL
1	+5V	1	NC
2	DGND	2	VDD3V
3	GND	3	NC
4	D-	4	TAG_SWCLK
5	CAN High	5	NC
6	D+	6	GND
7	CAN Low	7	NC
8	+5V	8	TAG_SWDI
9	GND	9	NC
10	NC	10	NRST
11	GND	11	NC
12	NC	12	TAG_SWDO
13	NC	13	DGND
14	NC	14	DGND
15	NC	15	+5V
16	NC	16	NC

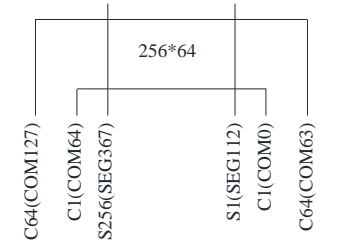
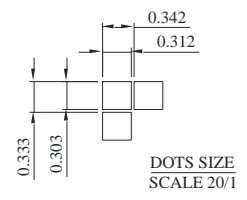

5. Absolute Maximum Ratings

Item	Symbol	Min	Typ	Max	Unit
Operating Temperature	TOP	-20	—	+70	°C
Storage Temperature	TST	-30	—	+80	°C

Note: Device is subject to be damaged permanently if stresses beyond those absolute maximum ratings listed above
1. Temp. $\leq 60^{\circ}\text{C}$, 90% RH MAX. Temp. $> 60^{\circ}\text{C}$, Absolute humidity shall be less than 90% RH at 60°C

6. Electrical Characteristics

Item	Symbol	Condition	Min	Typ	Max	Unit
Supply Voltage	+5V	—	4.4	5	5.6	V
Supply Product current	I (mA)	—	355	425	500	mA

7. Block diagram

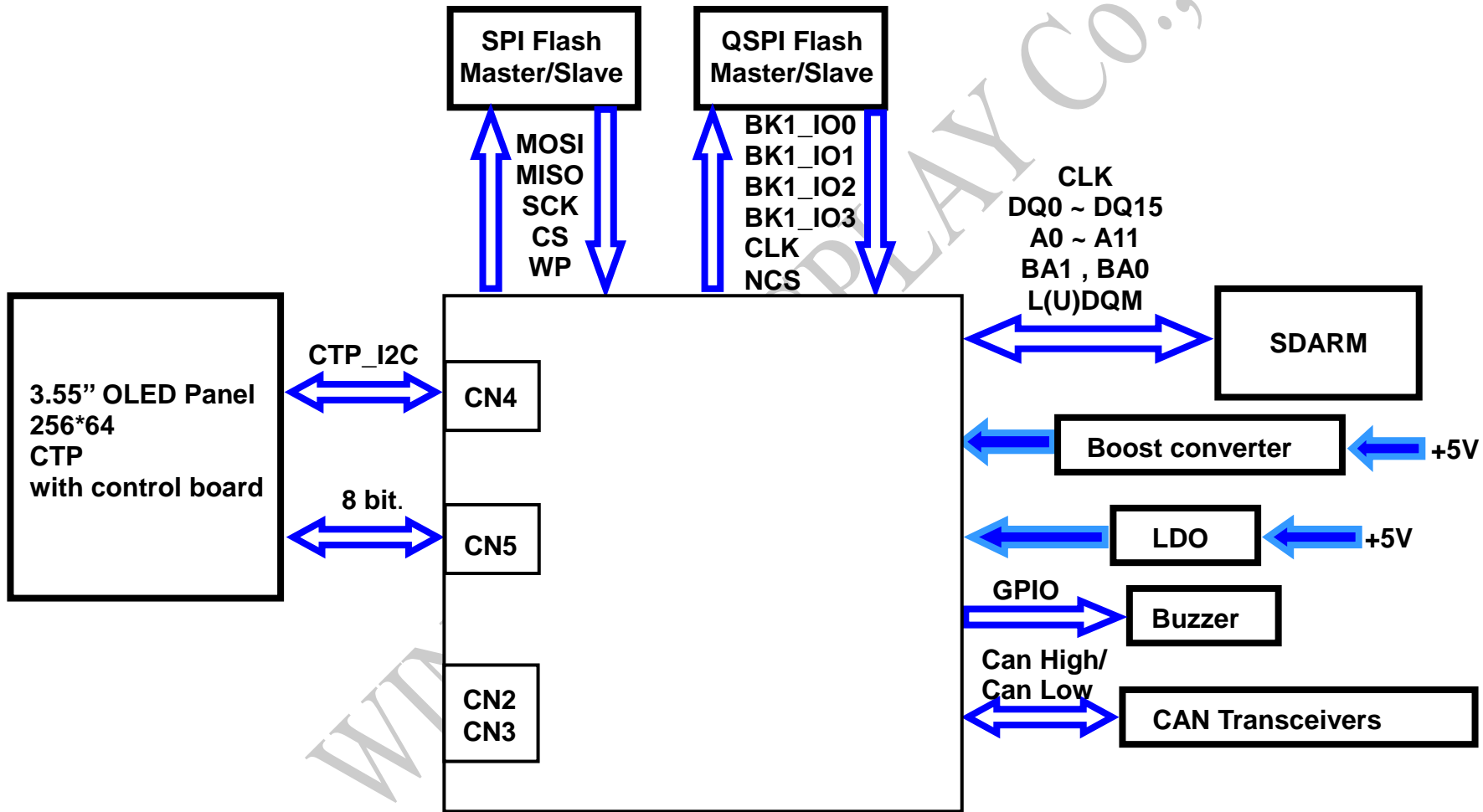

8. Interface

CN1 definition:

Pin	Symbol	Function	Remark
1	+5V	Power supply 5V input	Input
2	DGND	Reserved	Output
3	GND	Power supply GND input	Input
4	D-	Reserved	I/O
5	CAN High	CAN bus D+	I/O
6	D+	Reserved	I/O
7	CAN Low	CAN bus D-	I/O
8	+5V	Reserved	Output
9	DGND	Reserved	Output
10	NC	Reserved	
11	DGND	Reserved	Output
12	NC	Reserved	
13	NC	Reserved	
14	NC	Reserved	
15	NC	Reserved	
16	NC	Reserved	

CN2 definition:

Pin	Symbol	Function	Remark
1	NC	Reserved	
2	VDD3V		Input
3	NC	Reserved	
4	TAG_SWCLK		
5	NC	Reserved	
6	GND		
7	NC	Reserved	
8	TAG_SWDI		
9	NC	Reserved	
10	NRST		
11	NC	Reserved	
12	TAG_SWDO		
13	DGND		
14	DGND		
15	+5V		Input
16	NC	Reserved	

9. Reliability

Content of Reliability Test (Wide temperature, -20°C~70°C)

Environmental Test			
Test Item	Content of Test	Test Condition	Applicable Standard
High Temperature storage	Endurance test applying the high storage temperature for a long time.	80°C 96hrs	—
Low Temperature storage	Endurance test applying the low storage temperature for a long time.	-30°C 96hrs	—
High Temperature Operation	Endurance test applying the electric stress (Voltage & Current) and the thermal stress to the element for a long time.	70°C 96hrs	—
Low Temperature Operation	Endurance test applying the electric stress under low temperature for a long time.	-20°C 96hrs	—
High Temperature/ Humidity Operation	Endurance test applying the high temperature and high humidity Operation for a long time.	40°C,90%RH 96hrs	—
Temperature Cycle	<p>Endurance test applying the low and high temperature cycle.</p> <p style="text-align: center;"> -20°C 25°C 70°C ← → 30min 5min 30min 1 cycle </p>	-20°C /70°C 30 cycles	—
Mechanical Test			
Vibration test	Endurance test applying the vibration during transportation and using.	Frequency:10~55Hz amplitude:1.5mm Time:0.5hrs/axis Test axis:X,Y,Z	—
Others			
Static electricity test	Endurance test applying the electric stress to the finished product housing.	Air Discharge model ±4kv,10 times	—

*** Supply voltage for OLED system =Operating voltage at 25°C

Test and measurement conditions

- All measurements shall not be started until the specimens attain to temperature stability. After the completion of the described reliability test, the samples were left at room temperature for 2 hrs prior to conducting the failure test at 23±5°C; 55±15% RH.
- All-pixels on/off exchange is used as operation test pattern.
- The degradation of Polarizer are ignored for High Temperature storage, High Temperature/ Humidity Storage, Temperature Cycle

Evaluation criteria

- The function test is OK.
- No observable defects.
- Luminance: > 50% of initial value.
- Current consumption: within ± 50% of initial value.

WINSTAR DISPLAY Co., Ltd.

10. Display Usage

Functional description

Smart Display can be used to display the coordinate, status and data information provided by the connected HOST device. Customers can configure the position coordinates they want to display in normal operation mode (COB-ID = 0x7B).

The Display is designed to be easily connected to a controller network, and to operate with minimum setup or knowledge of the SDO configuration on the controllers.

Splash Screen

The default splash image of OLED 3.55" is shown as below.



- ✓ This product is produced as a generic product. If you require a custom splash image for your application, contact us to discuss further.

Acquisition of Displayed Data

The Smart Display can acquire the data that it displays by using the CANopen SDO protocol.

On Pre-operational mode, customers can set the coordinates of objects through SDO; On operational mode, customers can send data of objects through SDO, please see below.

Example:

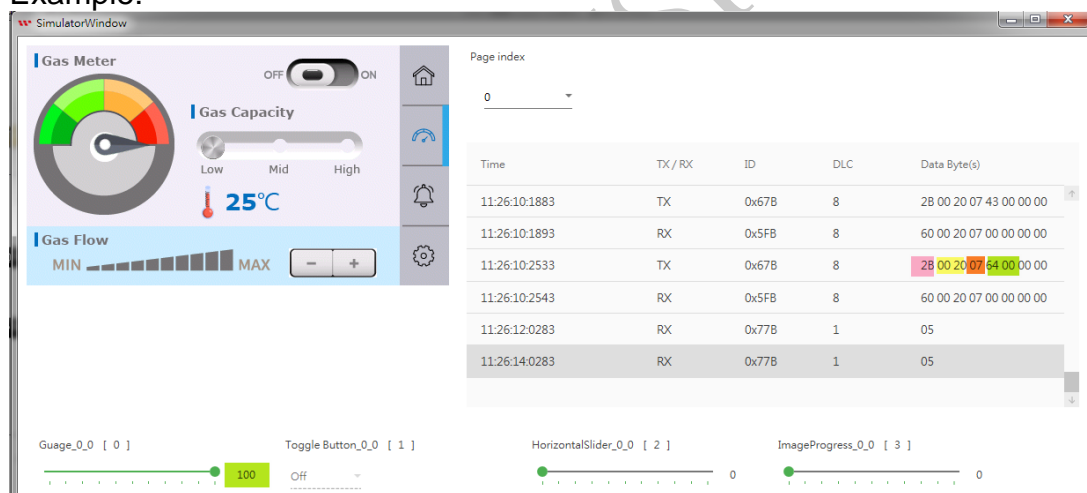

The client request :

Data length = 2 bytes

600 + Serv NodeId	0	2B	Index	Sub index	d1	d0	x	x
----------------------	---	----	-------	--------------	----	----	---	---

X : undefined. Put 0

To write the 2 byte data : 0x0064 in the object dictionary of node 7B at index 0x2000, sub-index 7, sends :

67B 2B 00 20 07 64 00 00 00

If success, the node 7B responds :

5FB 60 00 20 07 00 00 00 00

Configuring the Display

Winstar Smart Display CAN series offers an out-of-the-box CANopen development experience that will lower customers' development costs and speed time-to-market expectations.

The Smart Display can use wide-temperature are designed to support control applications in harsh operating conditions, which designed to be connected to a variety of different situation combinations, such as automotive, marine, power generation and oil-and-gas.

The Smart Display comes with standard UI objects to get customers project off the ground quickly. If customers need custom UI objects support, our engineers are here to help. Send over your contents in PNG/JPG format, we will send over a new set of UI objects within 3~5 working days.

The Smart Display is defined as a slave device, which is controlled by master device via CAN bus command to render display content on the display screen and return touch event data with protocol objects.

Node ID when Standalone

If the display is powered up standalone, the node id will default to 0x7B.

Configuring the Main Screen

The screen on the display is 265x64 pixels.

The co-ordinate system used to specify the location of an item on the screen is shown in the diagram below. The coordinates are (x,y) where 'x' is the horizontal offset from the left, and 'y' is the vertical offset from the top.

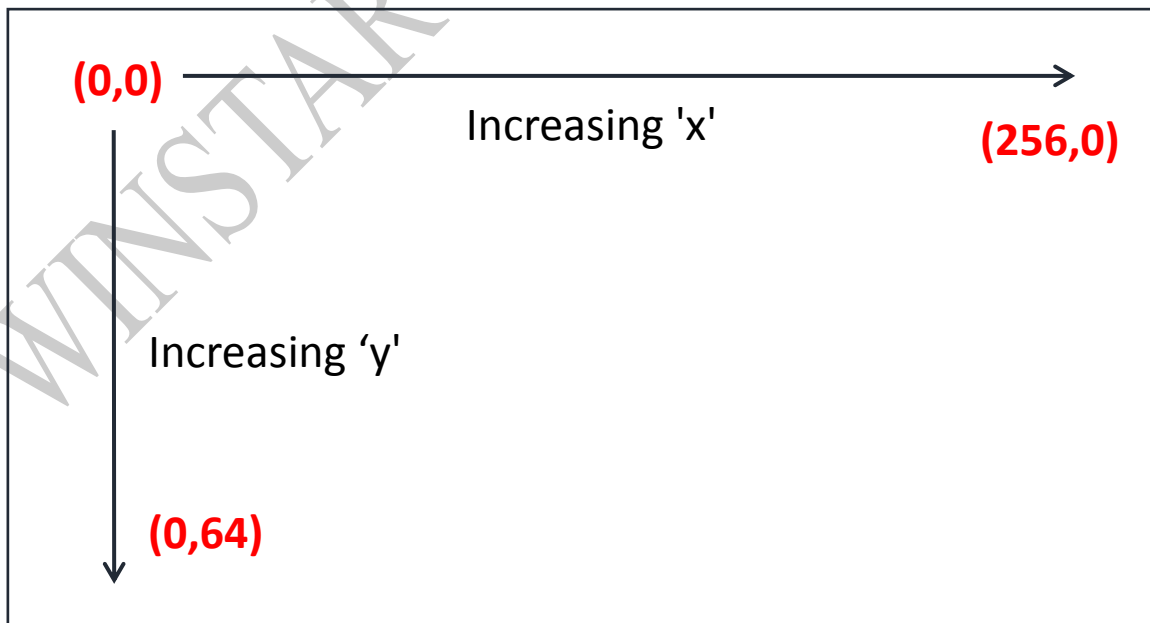

Item Object Dictionary

There are 64 objects entries which are for configuration of the items that can be displayed on

the screen in the latest F/W version. These are at location 0x2000 to 0x203F. Each object fully defines one screen item.









Each item has a set of sub-index items which are used to control the coordinate of the item. The exact functionality varies depending on the type of item selected. The template object is shown below:



Object List (0x2000 to 0x2009)

Object Index 0x2000 to 0x2009	Name	type	Description
Sub 0	Number of Entries	UNSIGNED8	9
Sub 1	Type	UNSIGNED8	style of Object
Sub 2	Reserve		
Sub 3	X position	INTEGER16	The object's X position
Sub 4	Y position	INTEGER16	The object's Y position
Sub 5	Number of Style	INTEGER16	The photo of style
Sub 6	Reserve		
Sub 7	Value 1	UNSIGNED16	Data to smart display from HOST
Sub 8	Value 2	UNSIGNED16	Data from smart display to HOST
Sub 9	Text	VISIBLE_STRING	Show strings (Unicode)max to 50 Character

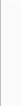
Sub 1 – Type

The item type is selected according to the table below:

Data	Description	Example Image
0	Empty	--
1	Reserve	--
2	Empty	--
3	Reserve	--
4	Button	
5	Toggle Button	
6	Empty	--
7	Empty	--
8	Check Box	
9	Empty	--
10	Battery	
11	Graph	
12	Indicator	
13	Empty	--
14	Image Progress	
15	Group button	













16	Animated Image	
17	Number	65535
18	Text	ABC
19	Custom Widget	100°C 
20	Digital Clock	00:45 AM

Sub 3&4 – x and y position

Each item is drawn on screen by setting a draw rectangle. This rectangle is a bounding rectangle sized to fully enclose the item that is being drawn. The co-ordinates specify the position of the top left of this bounding rectangle.

Sub 5 –Number of Style

Various types of icons

Button/Toggle Button	icon
0	
1	
2	
3	
4	
5	
6	
7	
8	
9	
10	
11	

Check Box	icon
0	

1	
---	---

Battery	icon
0	
1	

Graph	icon
0	









Indicator	icon
0	
1	
2	

Image Progress	icon
0	

Group button	icon
0	 
1	 



Digital Clock	icon
0	

Text	icon
0	

1	ABC
2	ABC

Number	icon
0	65535
1	65535
2	65535

Animated Image	icon
0	

Custom Widget	icon
0	
1	

Sub 7&8 –Data send and receive

HOST sends numeric data to Sub 7 to control Smart Display objects another HOST receives numerical data from Sub8.

HOST can be used on multiple platforms, such as **Computer, MCU, Raspberry Pi(with PiCAN2).**

Background(0x2100)

Object Index 0x2100	Name	type	Description
Sub 0	Data	UNSIGNED8	Background of number

Backlight(0x2101)

Object Index 0x2101	Name	type	Description
---------------------	------	------	-------------

Sub 0	Data	UNSIGNED8	Value(0~100)
-------	------	-----------	--------------

Buzzer(0x2102)

Object Index 0x2102	Name	type	Description
Sub 0	Number of Entries	UNSIGNED8	
Sub 1	Cycle	UNSIGNED8	Number of repetitions
Sub 2	High	UNSIGNED8	High level
Sub 3	Low	UNSIGNED8	Low level
Sub 4	Active	BOOLEAN	Send reverse status to turn on the buzzer. Ex: If the current active bit is true, send false bit and the buzzer is turned on.

Page(0x2103)

Object Index 0x2103	Name	type	Description
Sub 0	Number of Entries	UNSIGNED8	
Sub 1	Count	UNSIGNED8	Return to page number
Sub 2	Index	UNSIGNED8	Jump to number page

Mode(0x2104)

Object Index 0x2104	Name	type	Description
Sub 0	Number of Entries	UNSIGNED8	
Sub 1	Mode	UNSIGNED8	'0x00' enter pre-operation '0x01' enter operation

The transmitted data must be mutually exclusive binary values. (If first send '1' then second data must to send '0' and so on....)

11. Example Screen Layout (General application)

Example Layout

The screen layout described in this section is intended to demonstrate the settings of screen items that can be used in the general application.



0x2000 Toggle Button
0x2001 Animated Image
0x2002 Custom Widget
0x2003 Custom Widget
0x2004 Toggle Button

0x2005 Toggle Button
0x2006 Toggle Button
0x2007 Toggle Button
0x2008 Toggle Button
0x2009 Digital clock

12. References

[Sample code for Arduino Mega 2560](#)

WINSTAR DISPLAY